

B

1

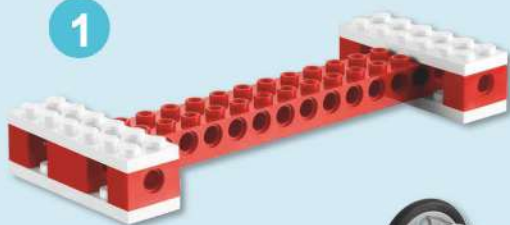

2

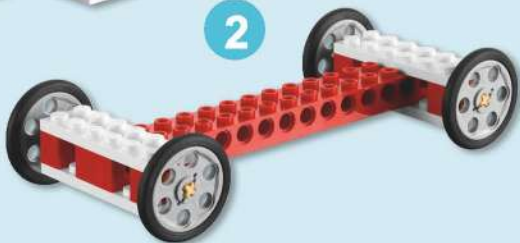

3



4



5



6



B1

B2

B3

B4

B5

B6

B1

B1

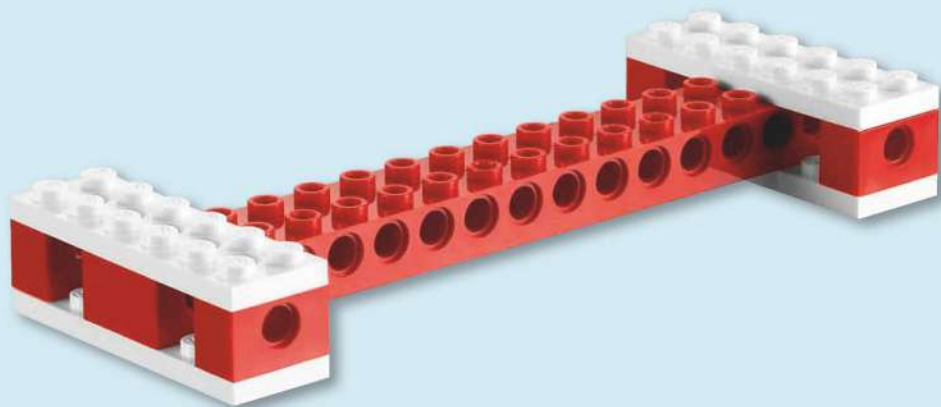

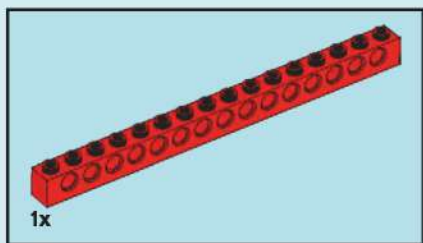

1

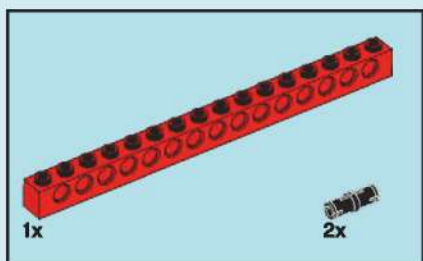
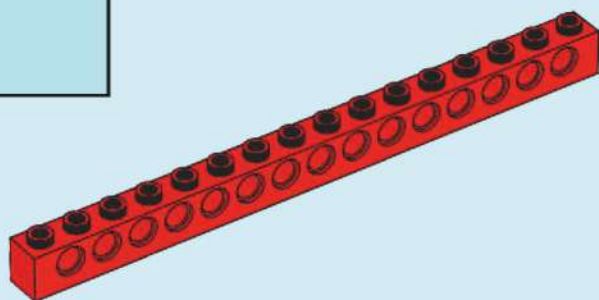

2

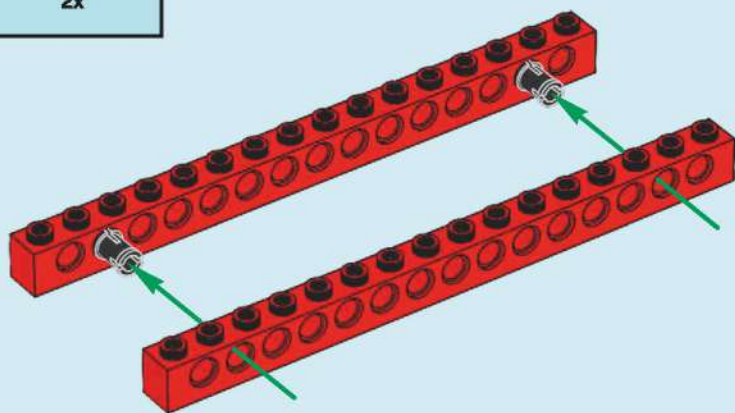

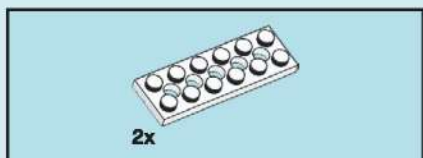

3

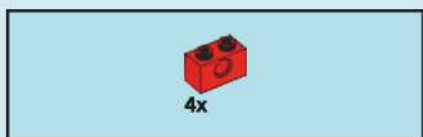
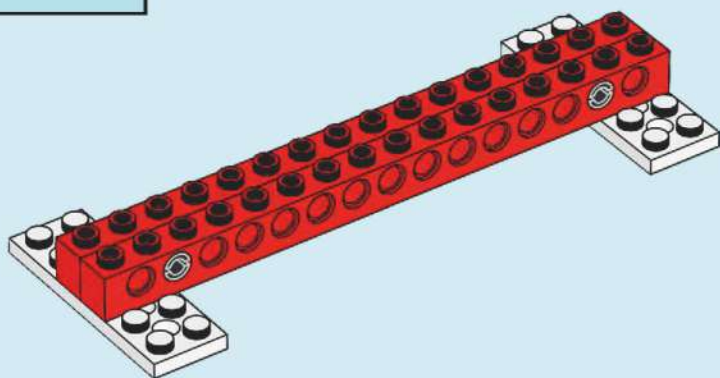

4

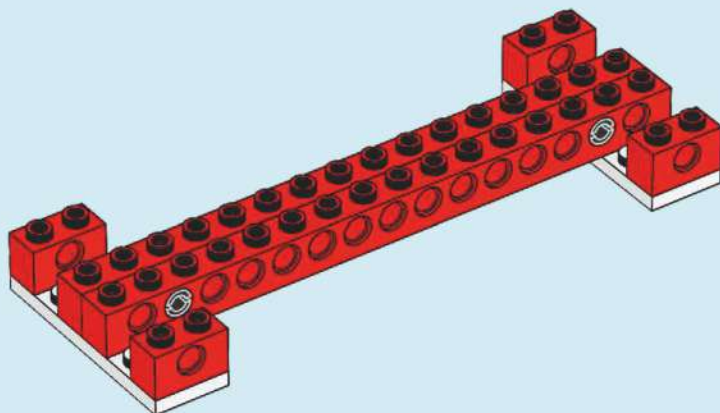

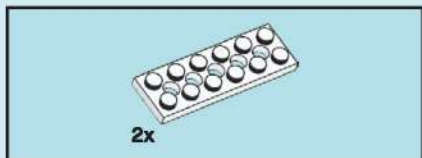

5

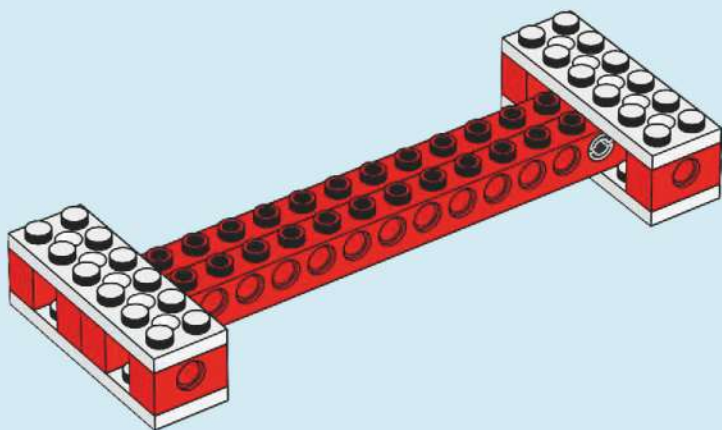

B2

B2

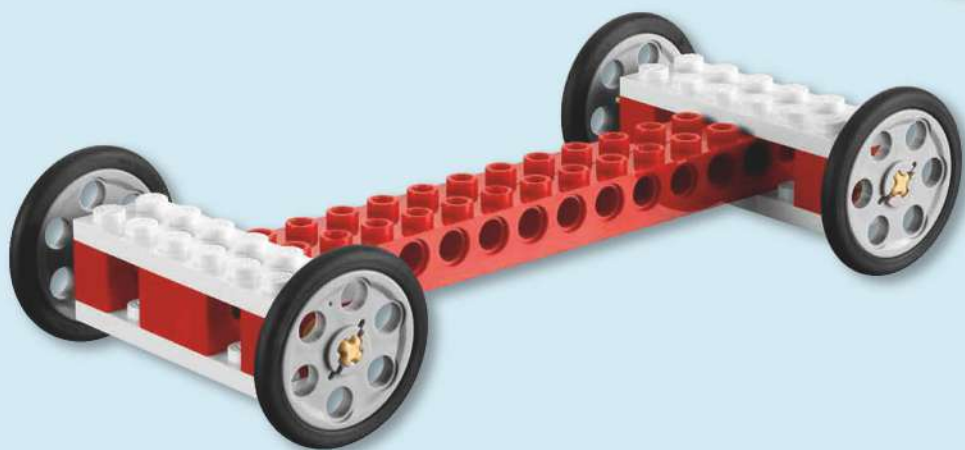

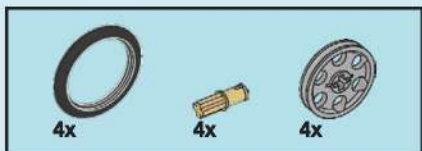
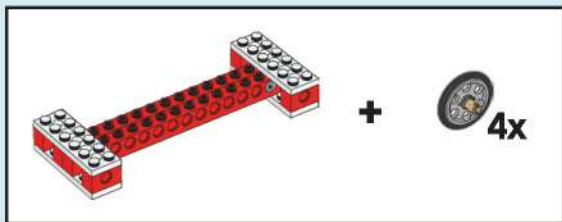

1

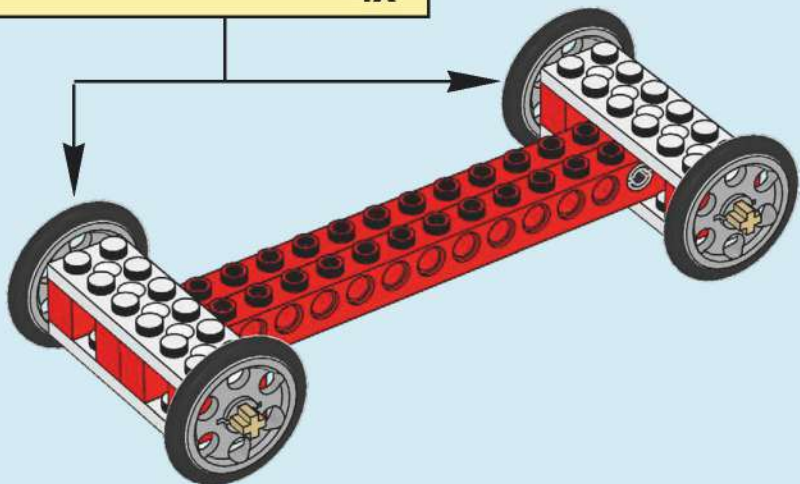
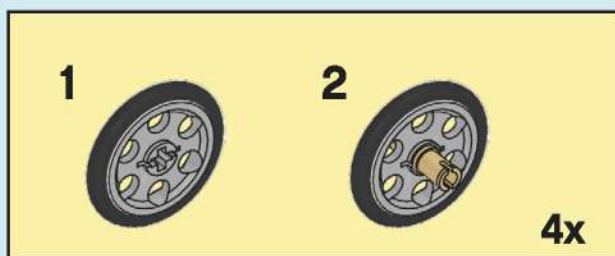

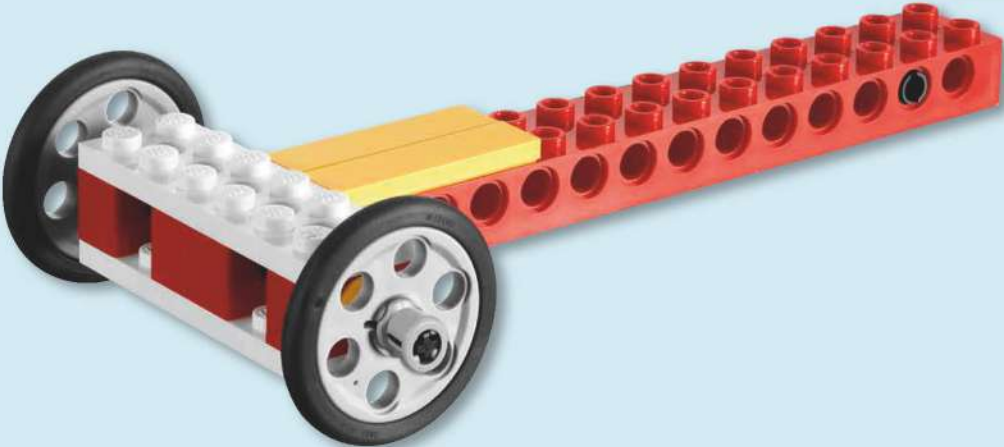

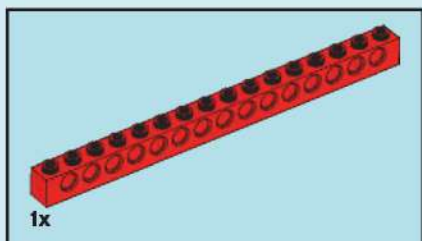

1

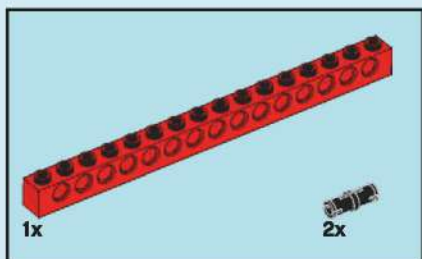
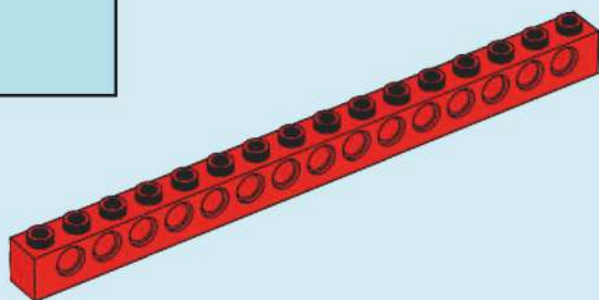

2

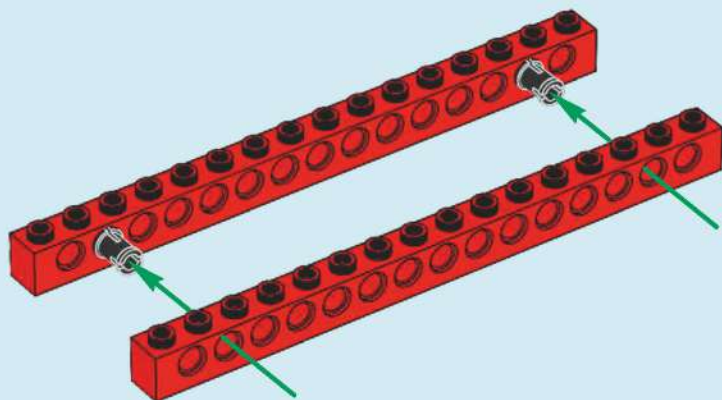

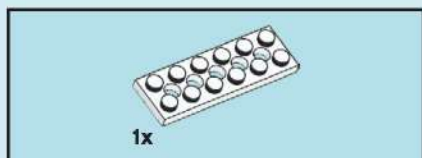

3

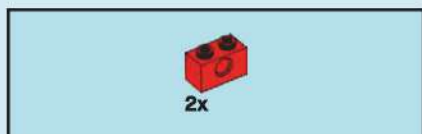
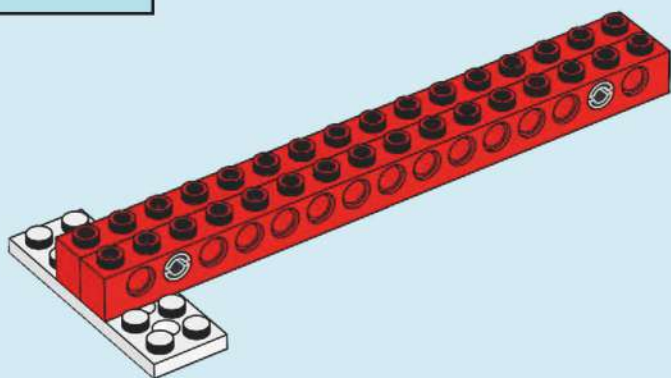

4

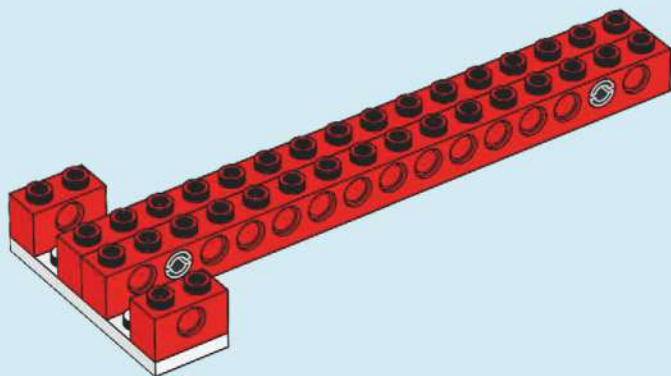



5

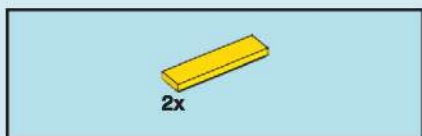
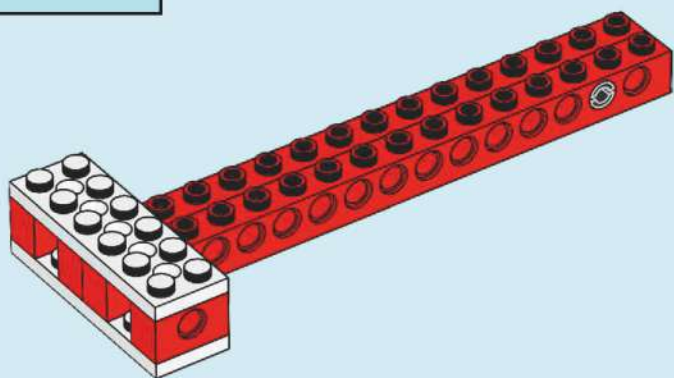

6

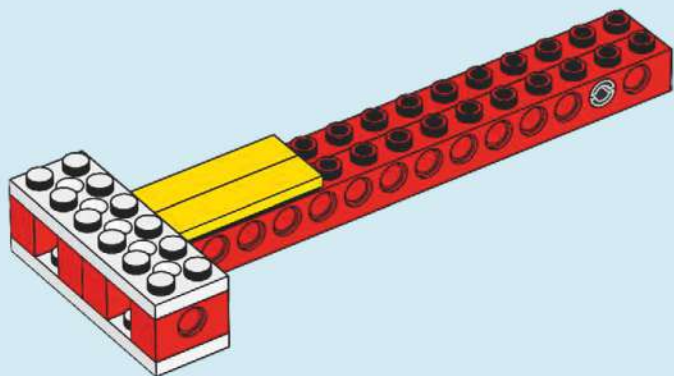

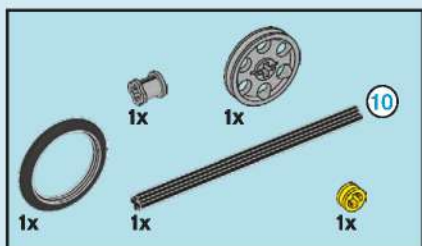

7

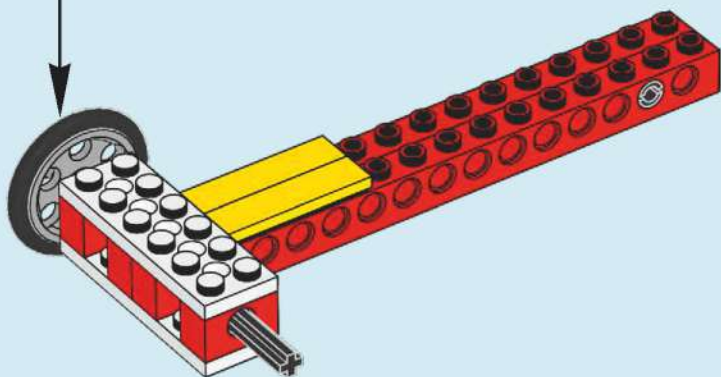
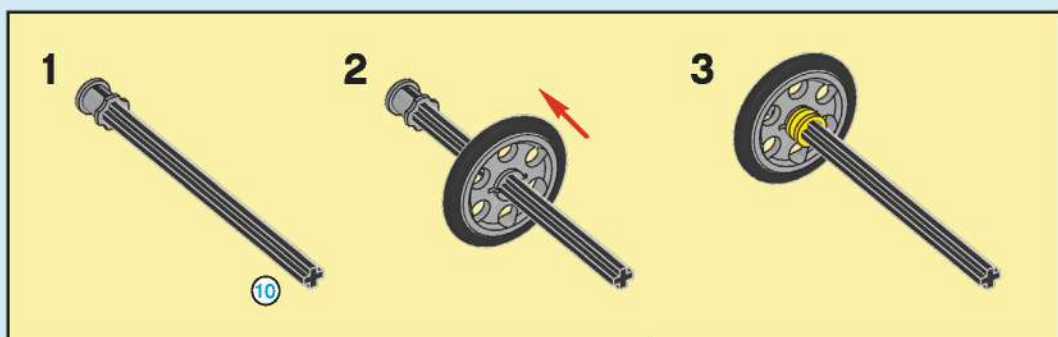
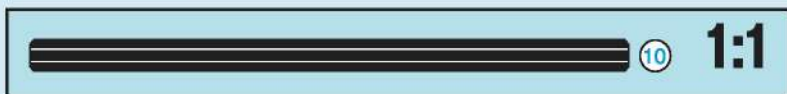



8

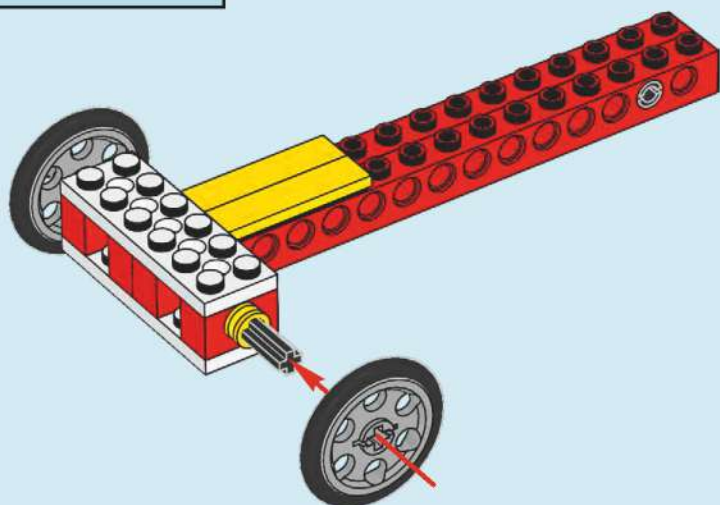

9

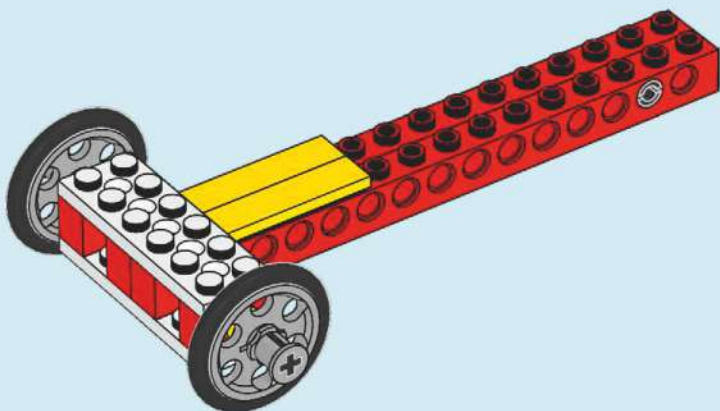

B4

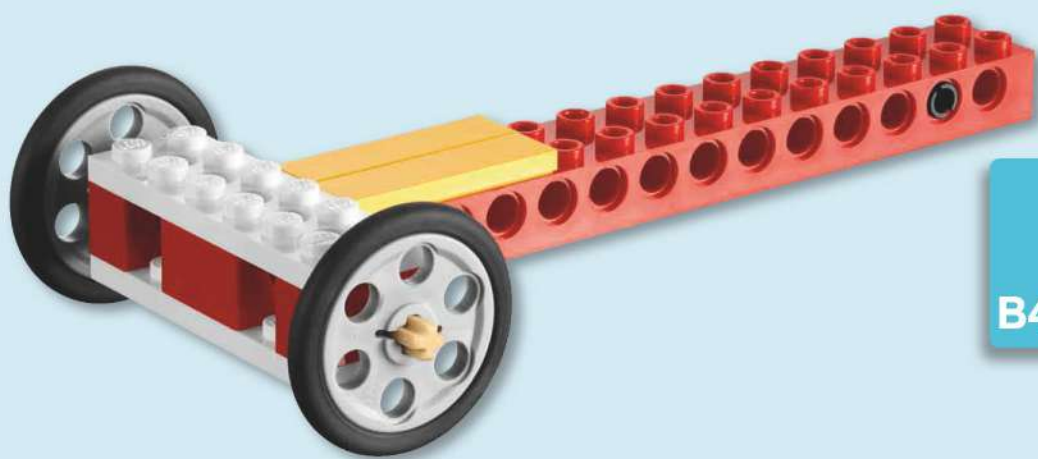

B4

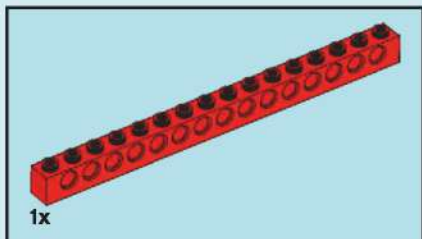

1

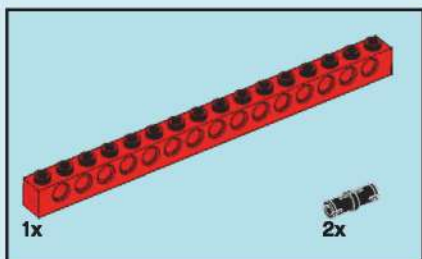
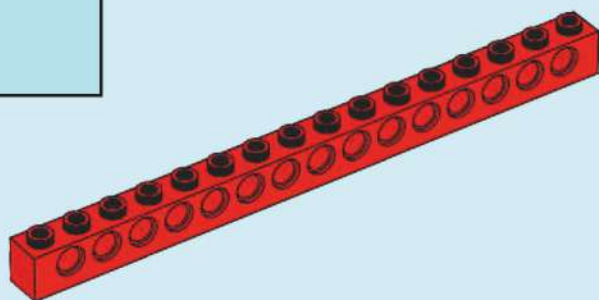

2

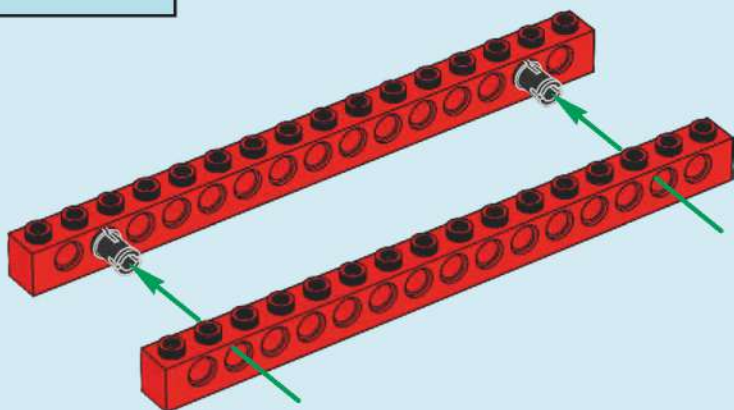

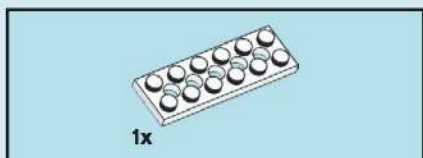

3

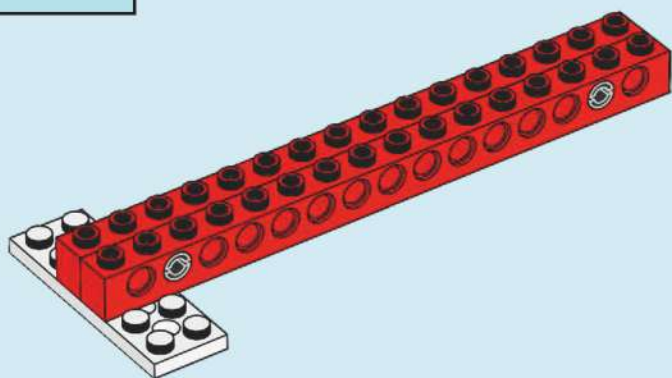

4

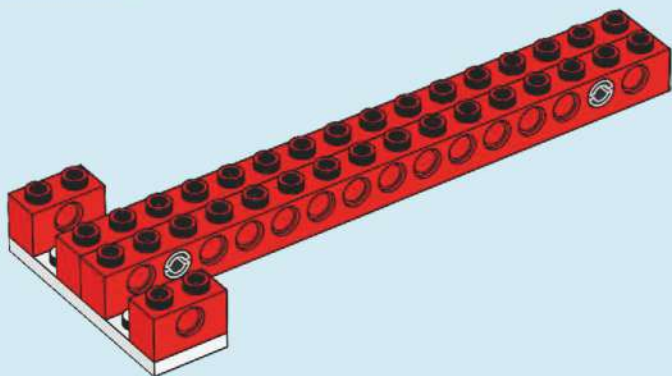



5

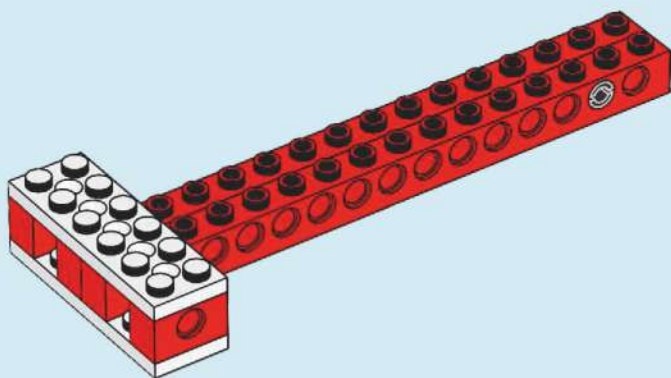

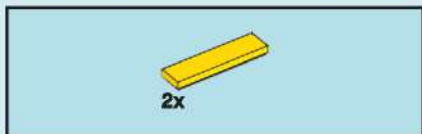

6

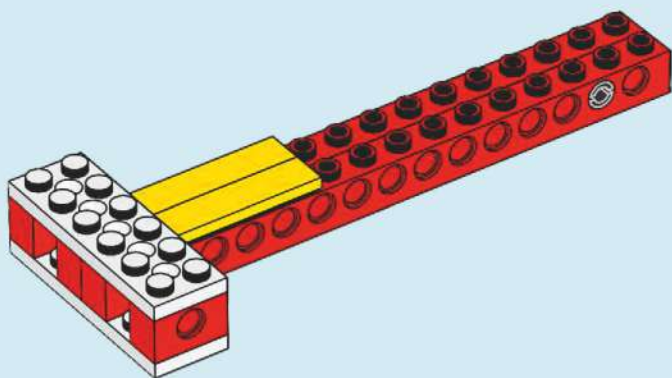

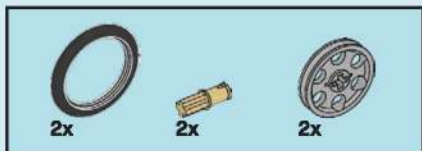

7

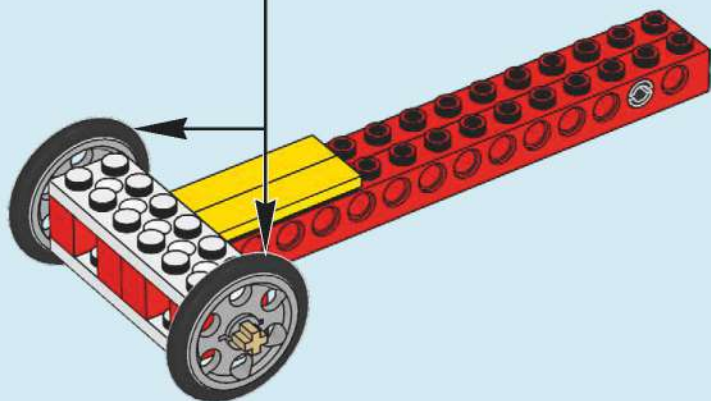
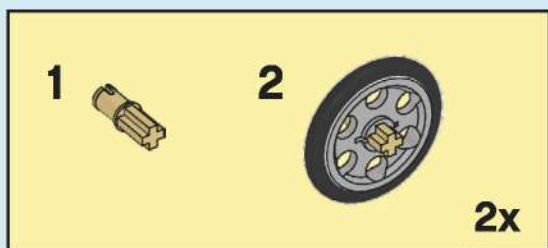

B5



B5

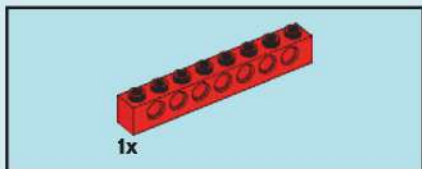

1

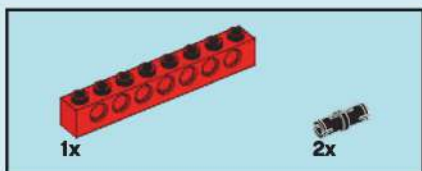

2

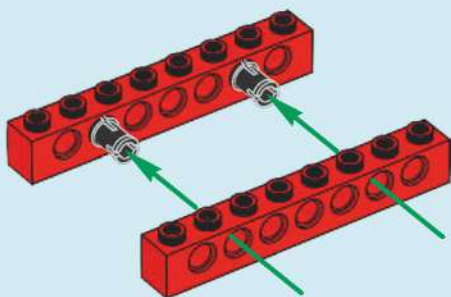

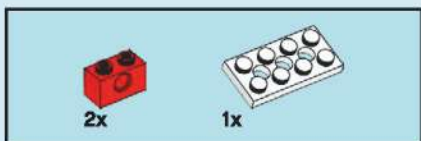

3

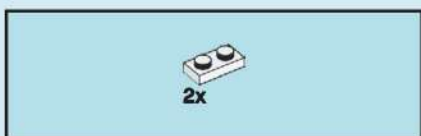
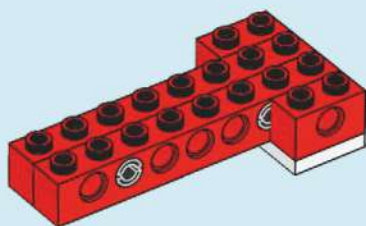
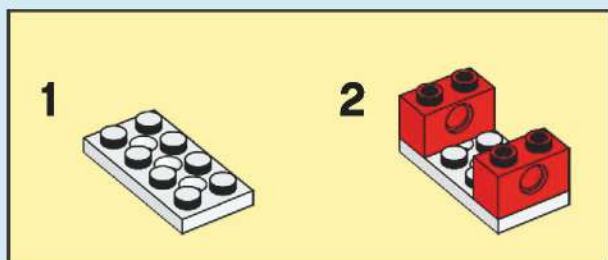

4

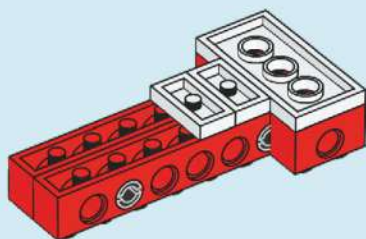



5

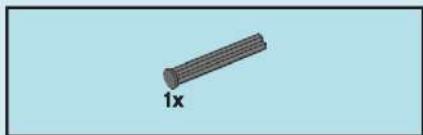
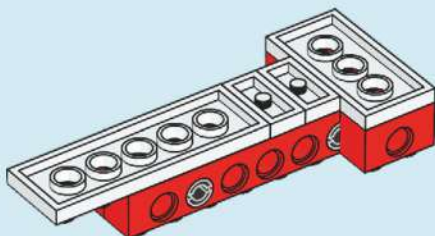

6

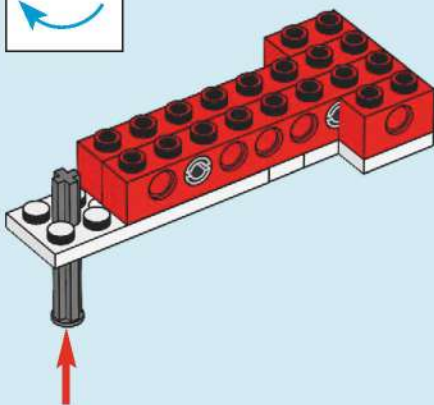

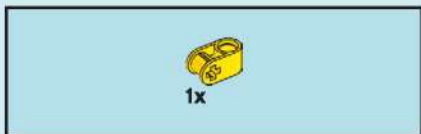

7

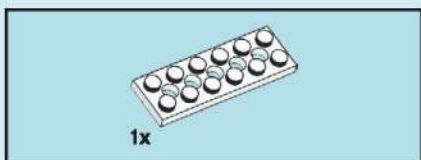
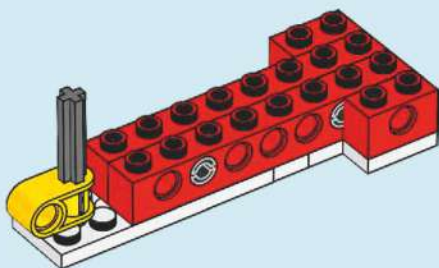

8

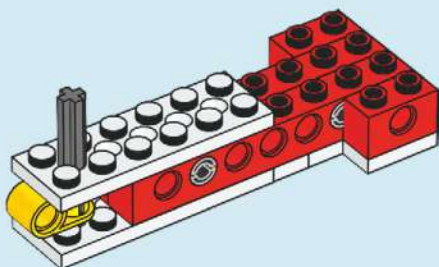

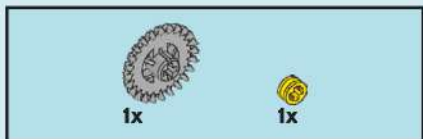

9

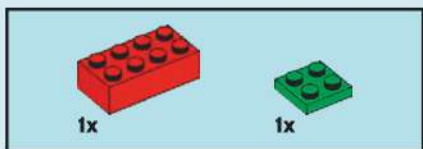
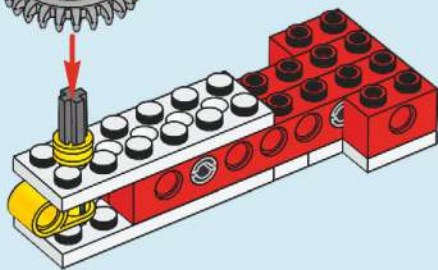
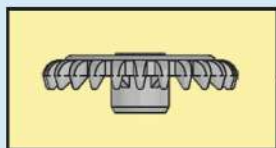

10

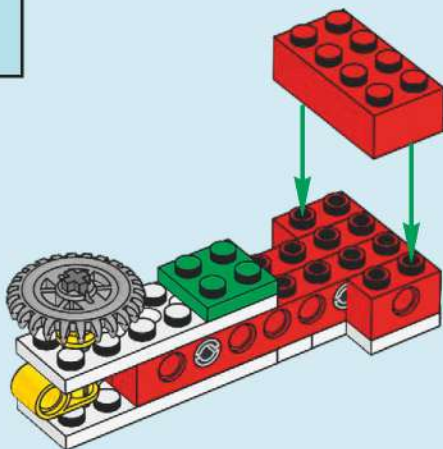

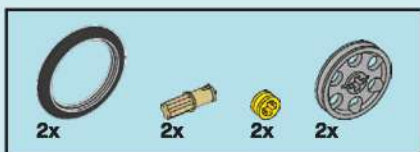

11

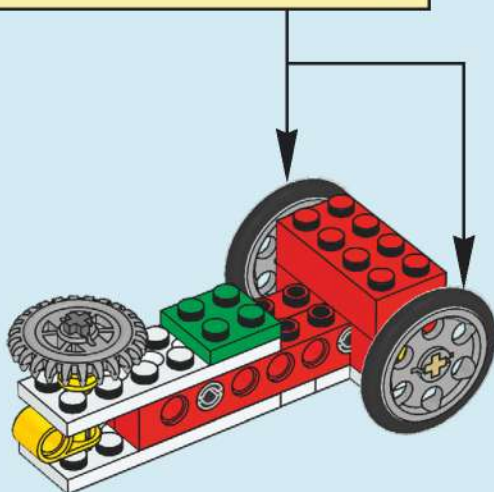
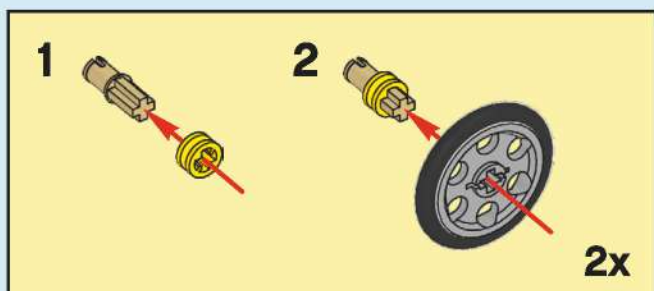

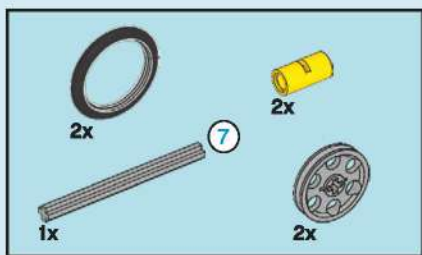

12

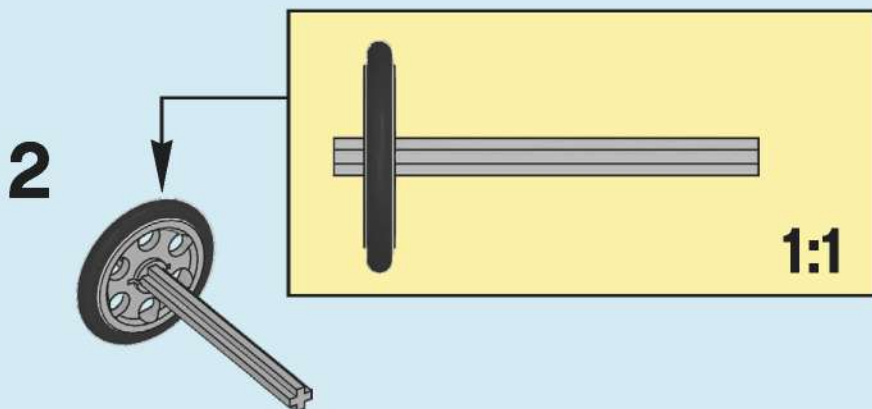

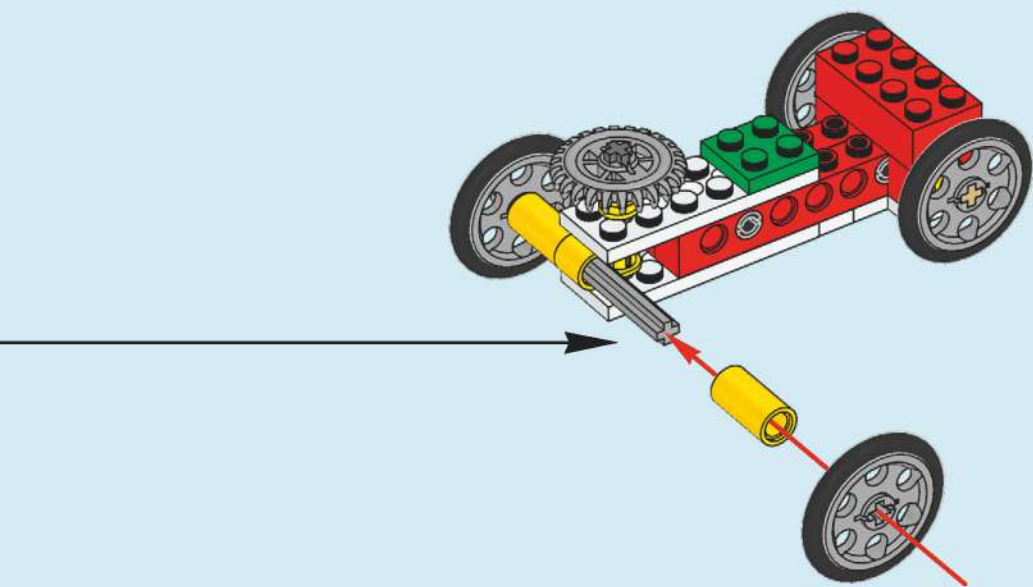

13

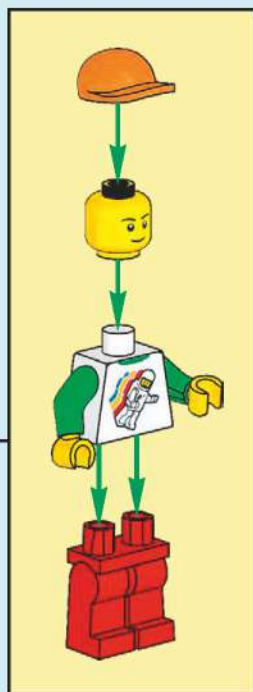
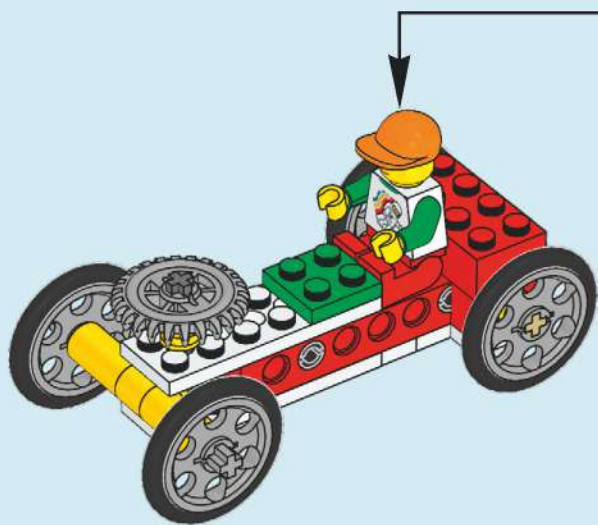



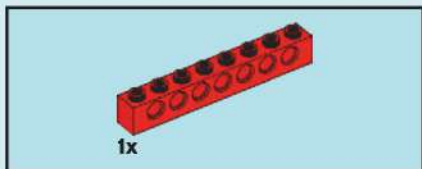

1

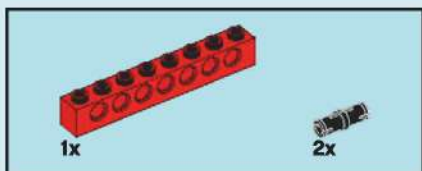
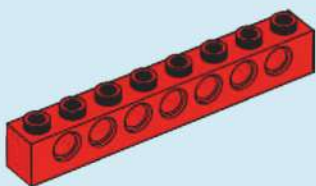

2

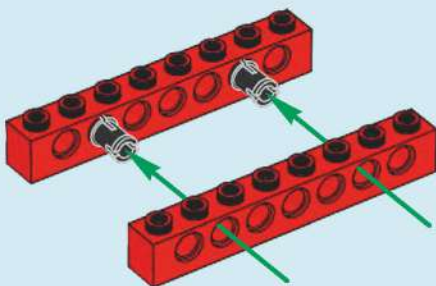

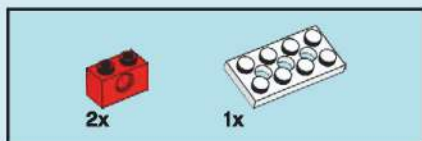

3

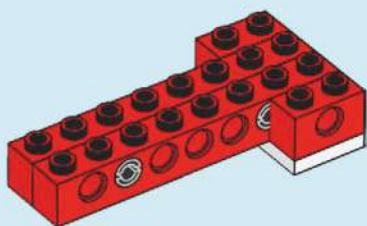
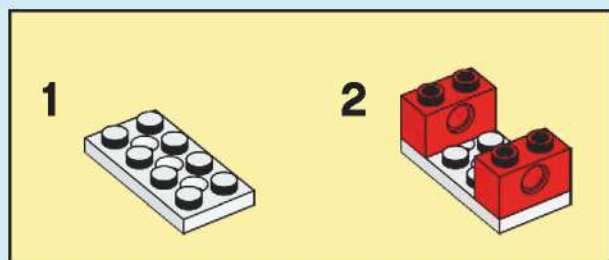

4

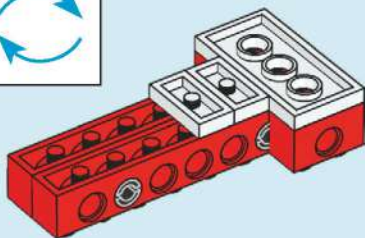



5

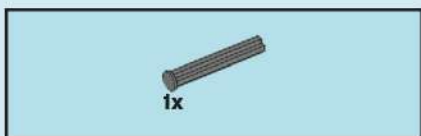
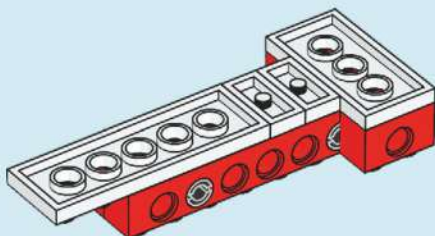

6

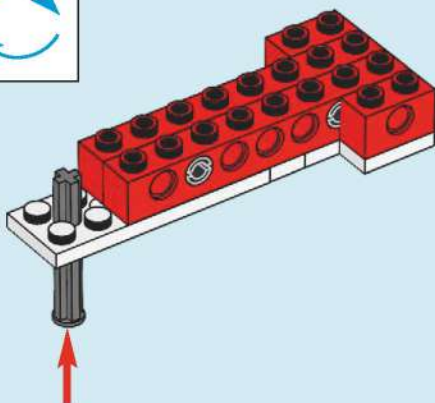



7

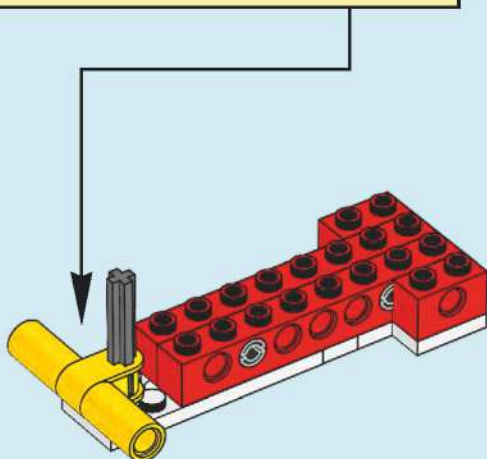
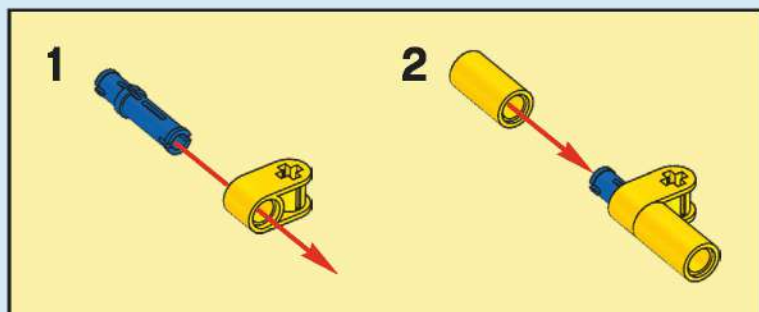



8

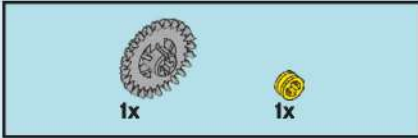
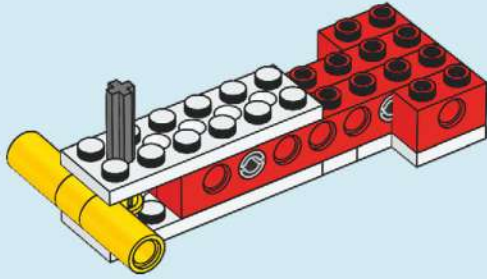

9

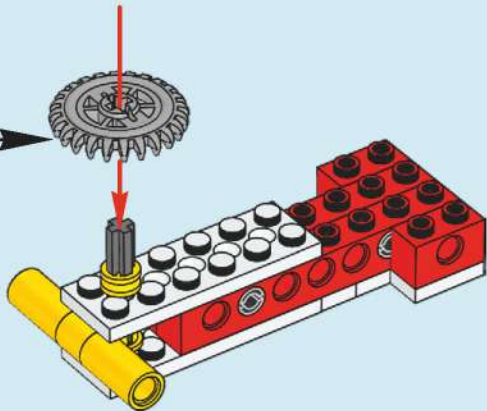
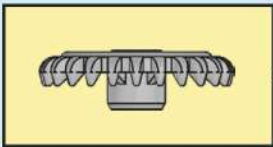

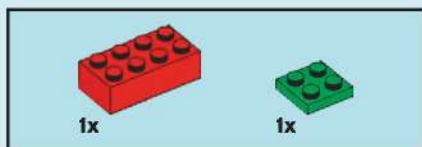

10

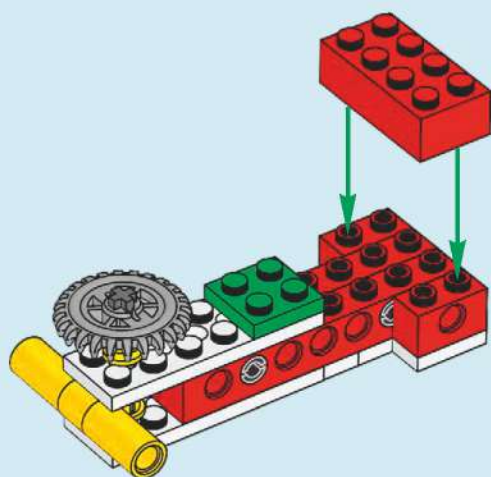



11

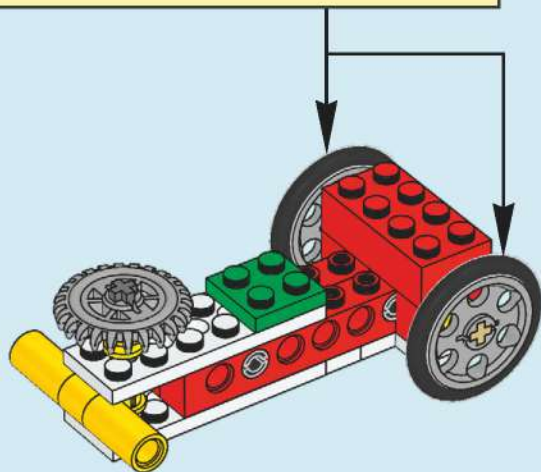
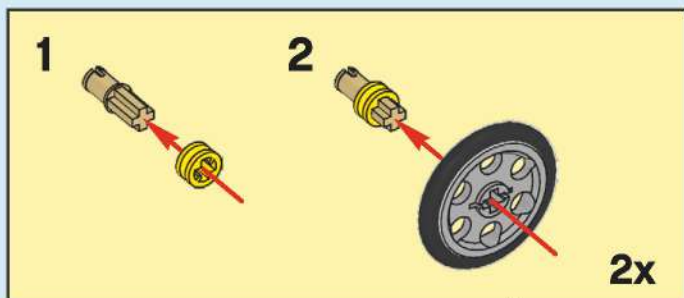

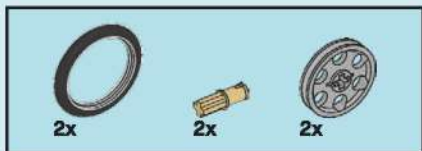

12

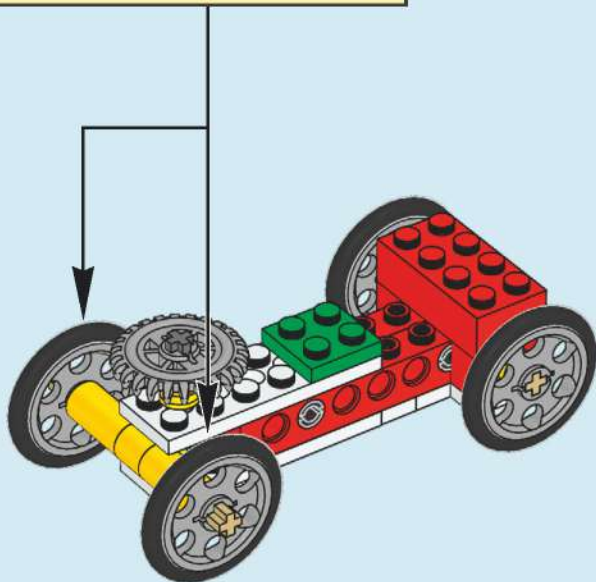
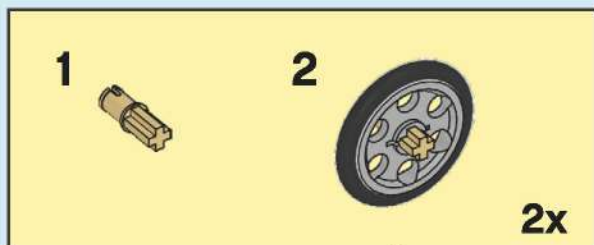

13

